

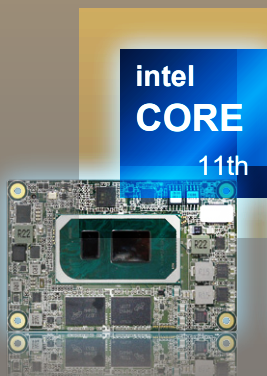

SMART INDUSTRY 4.0

Your One Stop Shopping for
COM-Express Module



COM Express Type 10
ACM-TGLUE0



COM Express Type 7
ACM-ICLDE7



COM Express Type 7
ACM-XD15B7

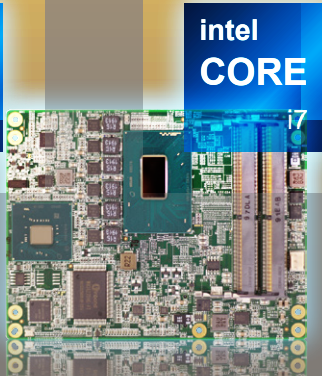

COM Express Type 6
ACM-XE21B6

IoT-enabled Automation Solution

COM-Express Module can be applied to various industrial applications such as computer numerical control (CNC) machines, real-time controls, human-machine interfaces, tool applications, medical imaging and diagnostics (in applications like an ultrasound), other applications requiring high resolution, HDR output with AI capabilities, network video recorders, machine vision and inspection, programmable logic controllers and robotics.



Digital Signage



KIOSK



HOME Automation



Industrial

ACM-TGLUE0

Intel Core i COM Express Type 10 Module
Powerful credit card-sized

55X84mm

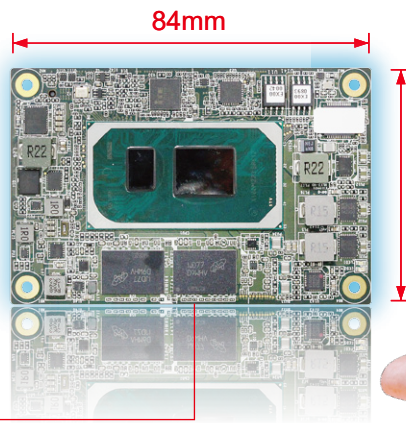

Product Matrix

Com Express Boards



Form Factor	COM Express type 10	COM Express type 7
Model Name	ACM-TGLUE0	ACM-ICLDE7
CPU	Intel®11 th Core™ I Processor	Xeon® D, LLC, up to 10c/20t CPU TDP up to 70W
Chipset	SoC	Intel Xeon D SoC
Memory	Onboard LPDDR4 4266 memory 16GB In-band ECC supported by SoC	4 x DDR4 SODIMM(Support ECC function) up to 128GB
Video Interface	1 x eDP, 1 x DDI port	-
SATA	2	2
Expansion Slot	4 x PCI-e 3.0 Lanes	24 x PCI-e 3.0 Lanes, 4 x PCI-e 3.0 x2 Lanes
Ethernet	1 x Intel I225LM GbE Lan, supports PXE Boot	1 x Intel I210AT GbE Lan, supports PXE Boot
USB	2 x USB 3.2 Gen2, 8 x USB 2.0	4 x USB 3.2 Gen1 , 4 x USB 2.0
GPIO	8-bit Digital I/O	8-bit Digital I/O
Serial Port	2 x COM Interface (TX/RX only)	2 x COM Interface (TX/RX only)
Audio	High Definition Audio interface	Intel HD Audio Channel
WatchDog Timer	0 ~ 255 seconds	1 ~ 255 seconds
Hardware Monitor	YES	YES

Com Express Boards



Form Factor	COM Express type 7	COM Express type 6
Model Name	ACM-XD15B7	ACM-XE21B6
CPU	Xeon® D1548	Intel® Core i7-9850H
Chipset	Intel Xeon D SoC	Intel CM246
Memory	2 x DDR4-2400MHz, SO-DIMM, up to 32GB Default configuration: 2 x 8GB	2 x 2666 DDR4 SODIMM up to 64GB
Video Interface	-	2 x DDI/1 x VGA
SATA	2	4
Expansion Slot	24 x PCI-e 3.0 Lanes, 7 x PCI-e 2.0 Lanes	16 x PCI-e 3.0 Lanes, 8 x PCI-e 2.0 Lanes
Ethernet	1 x Intel I210AT GbE Lan, 2 x GbE LAN	-
USB	4 x USB 3.0, 8 x USB 2.0	4 x USB 3.1, 8 x USB 2.0
GPIO	8-bit Digital I/O, 4-bit DI and 4-bit DO	8-bit Digital I/O, 4-bit DI and 4-bit DO
Serial Port	2 x COM Interface (TX/RX only)	2 x COM Interface (TX/RX only)
Audio	Intel HD Audio Channel	Intel High Definition Audio
WatchDog Timer	1 ~ 255 seconds	0 ~ 255 seconds
Hardware Monitor	YES	YES

ACM-TGLUE0

Intel Core i COM Express Type 10 Module

ACM-TGLUE0-COM Express mini Type 10 module is powered by the 11th Generation Intel® Core™ Processor Family which can deliver outstanding computing and up to 4 PCIe lanes Expansion, graphics, and media performance.

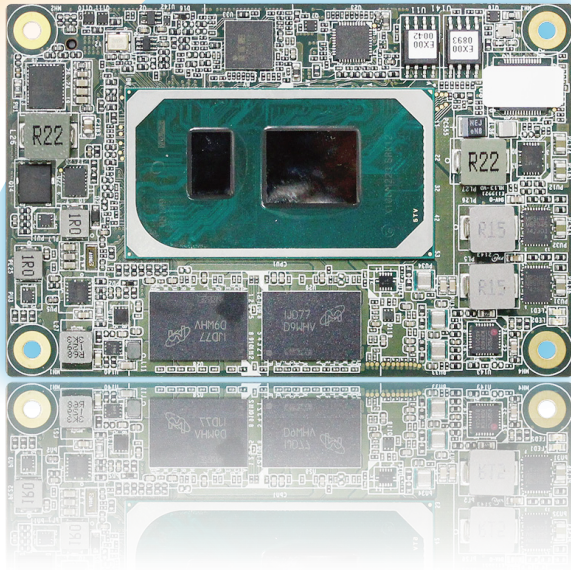

Features

- 11th Generation Intel® Core™ Processor Family (formerly Tiger Lake UP3)
- Onboard LPDDR4x Memory 16 GB
- 2.5 Gigabit Ethernet x 1
- eDP x 1 , DDI x 1
- High Definition Audio Interface
- SATA3.0 x 2 , onboard PCIe SSD 64GB
- USB 2.0 x 8, USB 3.2/2.0 x 2 (up to USB 3.2 Gen 2 support)
- 4 x PCI-Express x 1
- COM Express Type 10, Mini Size, 84 mm x 55 mm

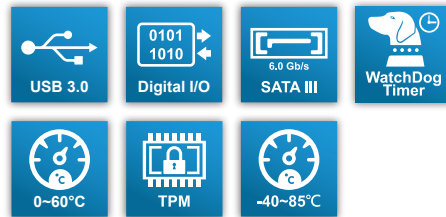

CPU Support

CPU	Core/Thread	Base Frequency/Turbo	TOP	Graphic	In-band ECC	Operating Temp
i7-1185G7E	4/8	1.8GHz/4.4GHz	15W (UP to 28W)	Intel®Iris® Xe Graphics	No	Commercial Temp
i5-1145G7E	4/8	1.5GHz/4.1GHz		Intel®Iris® Xe Graphics	No	Commercial Temp
i3-1115G7E	2/4	2.2GHz/3.9GHz		Intel®UHD Graphics	No	Commercial Temp
i7-1185G7E	4/8	1.8GHz/4.4GHz		Intel®Iris® Xe Graphics	Yes	Embedded/Industrial Extended Temp.
i5-1145G7E	4/8	1.5GHz/4.1GHz		Intel®Iris® Xe Graphics	Yes	Embedded/Industrial Extended Temp.
i3-1115G7E	2/4	2.2GHz/3.9GHz		Intel®UHD Graphics	Yes	Embedded/Industrial Extended Temp.
Celeron 6305E	2/2	1.8GHz/...	15W	Intel®UHD Graphics	No	Commercial Temp

ACM-ICLDE7

COM Express Type 7

ACM-ICLDE7-COM Express Basic Type 7 module is powered by Intel ICE LAKE D which can provide up to four 10 GbE interfaces and up to 32 PCIe lanes Expansion, is suitable for data center, server, and high-bandwidth video applications.

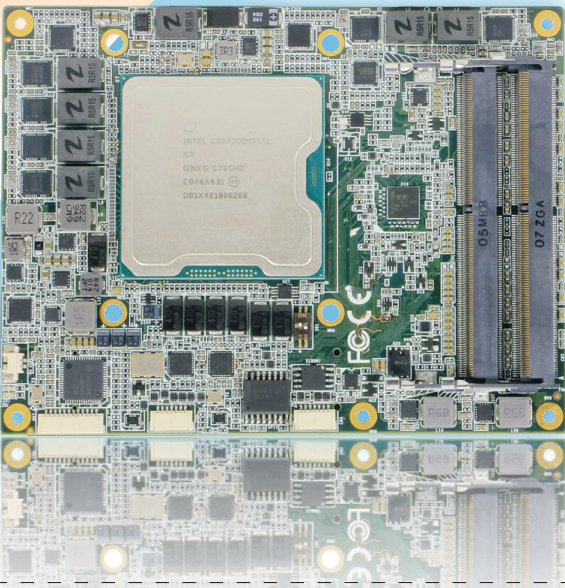

Features

- Intel® SoC XEON™ D LCC series, max TDP 70W
- DDR4 socket x4
- Gigabit Ethernet x 1, 10 GbE x4
- No Display, No Audio
- SATA x 2, USB3.0/2.0 x4
- PEG[x16], 1x PCIe[x8] + 4x PCIe[x2]
- GPIO x8, SMBus, I2C, LPC
- COM Express Basic size, Type 7, 125mmx95mm

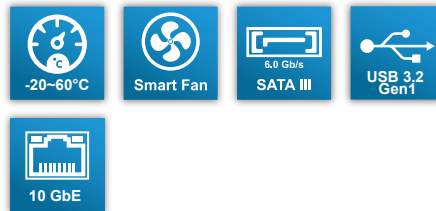

Block Diagram

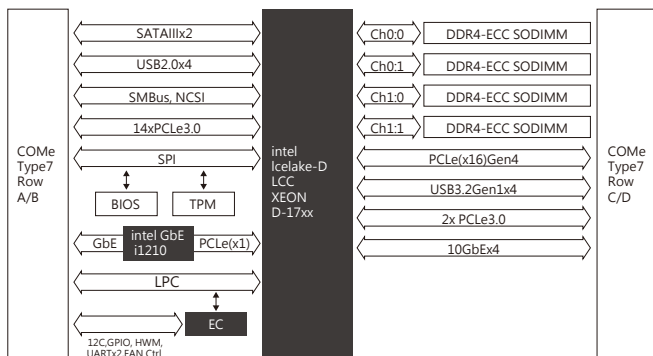

Embedded CPU Chart

ICELAKE-D LCC Sku	CPU Cores	TDP	Embedded sku
D-1746TER	10c	67W	Yes
D-1735TR	8c	59W	Yes
D-1732TE	8c	52W	Yes
D-1715TER	4c	50W	Yes
D-1712TR	4c	40W	Yes

ACM-XD15B7

COM Express Type 7

ACM-XD15B7-COM Express Basic Type 7 module is powered by Intel Xeon D which can provide up to four 10 GbE interfaces and up to 32 PCIe lanes Expansion, is suitable for data center, server, and high-bandwidth video applications.

intel
XEON D

Features

- Newest platform and highest performance COM Express Basic Type 7
- The Intel Xeon D Processor
- Xeon® D1548 2.0/2.6GHz 12MB(8 core)
- Support Two DDR4 ECC SODIMM , up to 32GB
- 32 PCI-e Lanes
- 2 x 10 GbE KR & NC-SI

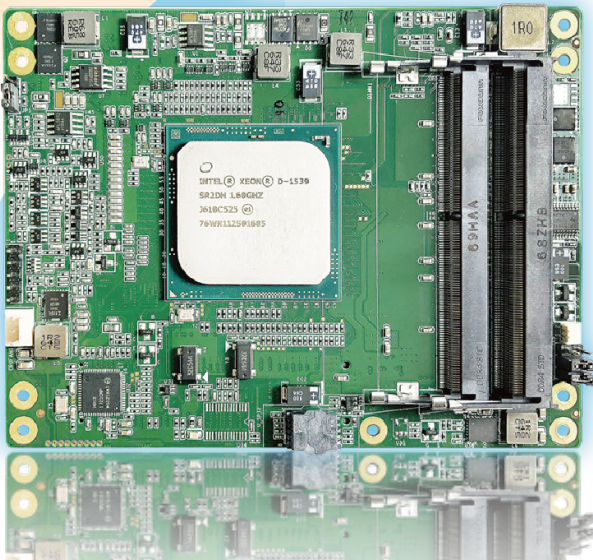
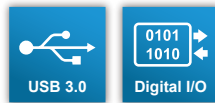

Dimension

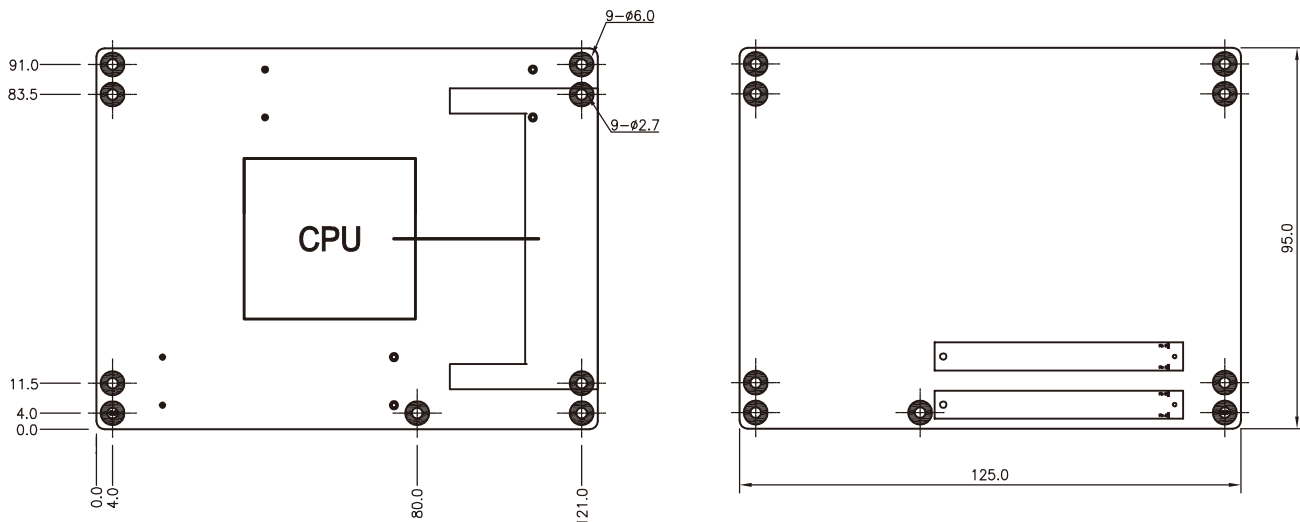

ACM-XE21B6

COM Express Type 6

ACM-XE21B6-COM Express Basic Type 6 module is powered by Intel Core i7/Xeon D which can offer rich features and up to 24 PCIe lanes Expansion, high graphical capabilities, and design flexibility to help facilitate quick deployment.

intel
CORE
i7

Features

- Newest platform and highest performance
COM Express Basic Type 6
- The Intel CM246 Chipset
- Intel® Core i7- 9850HE/Xeon 2176M Processor
- Support Two DDR4 SODIMM , up to 64GB
- 24 PCI-e Lanes
- 1x GbE

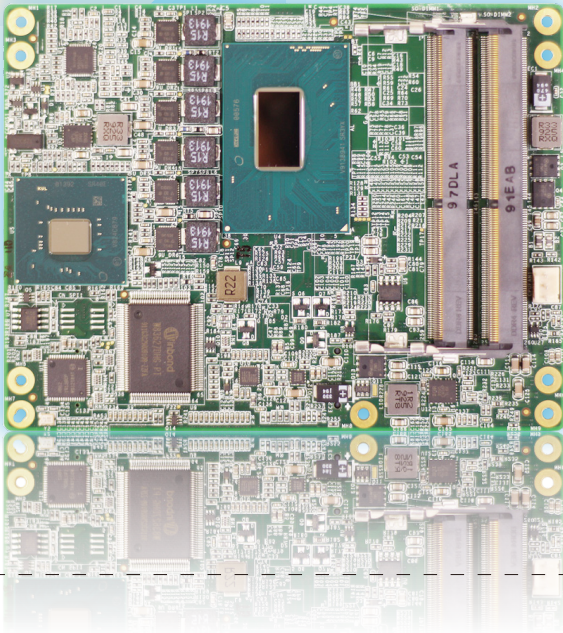
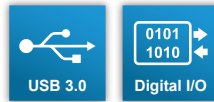

Dimension

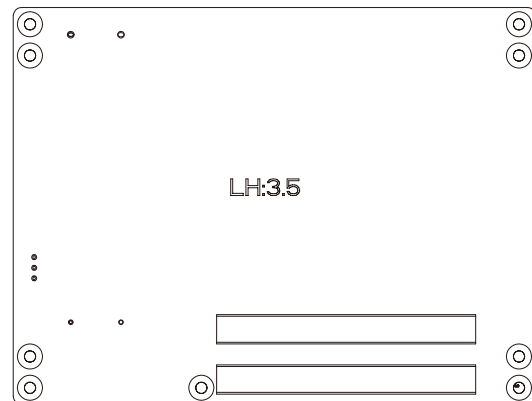
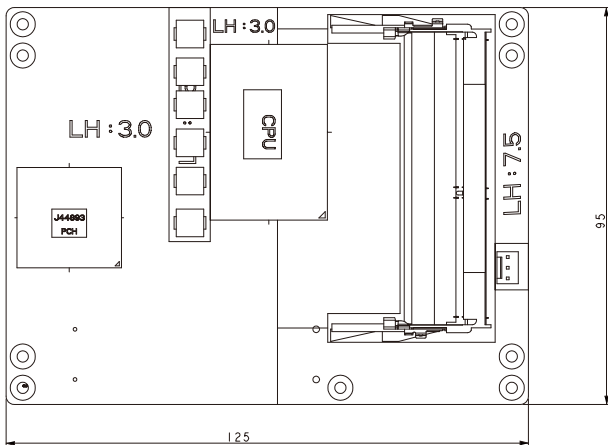



SMART INDUSTRY **4.0**

Your One Stop Shopping for
COM-Express Module

Acrosser Headquarters

241新北市三重區重新路5段609巷4號3樓之8
Rm. 8, 3F., No. 4, Ln. 609, Sec. 5, Chongxin Rd.,
Sanchong Dist., New Taipei City 241402, Taiwan
TEL: +886-2-29999000
FAX: +886-2-29992887

Acrosser Taichung Office

41475台中市烏日區僑仁街8號10樓~2 (10B)
10F.-2(10B), No. 8, Ciaoren St., Wuri Dist.,
Taichung City 41475, Taiwan
TEL: +886-4-23370715
FAX: +886-4-23373422

Acrosser USA Inc.

324 W. Blueridge Avenue,
Orange CA 92865
TEL: (714)728-6964

Acrosser China Subsidiary

深圳市欣扬通电子有限公司
深圳市福田区泰然八路安华工业区6号楼7层706室(邮编:518040)
Room 706, floor 7, building 6, Anhua Industrial Zone, Tairan 8th Road,
Futian District, Shenzhen, China(Postal:518040)
TEL: +86-755-83542210
FAX: +86-755-83700087