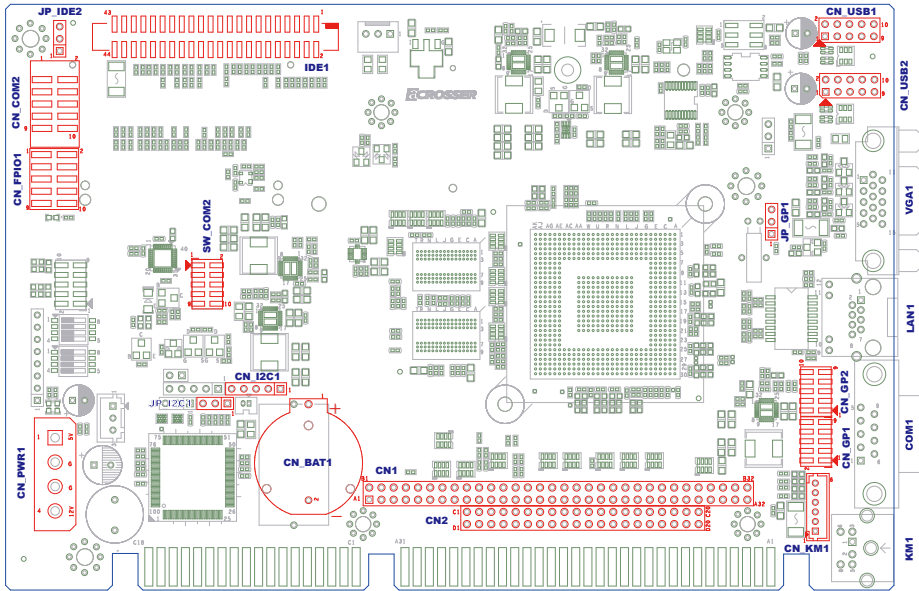
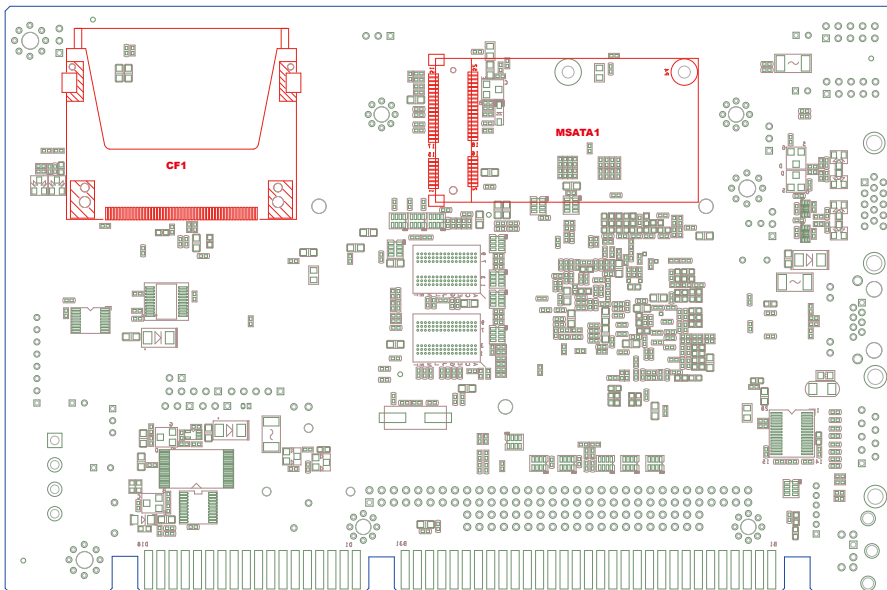
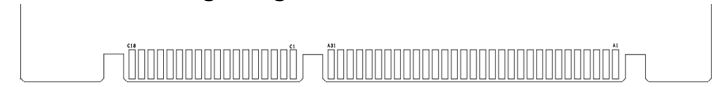

Top View

Bottom View

Headers/Connectors Pin Define & Jumper Setting (Top)
ISA1

(DC Power in option 1)

Standard ISA Edge Finger

CN_PWR1

(DC Power in option 2)

ATX 4Pin DC +5V & +12V Power in Peripheral Connector

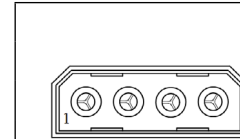

Pin #	Signal
4	+12V (1.2A min)
3	GND
2	GND
1	+5V (4A min)

CN1
CN2

Standard PC/104 Module Connector

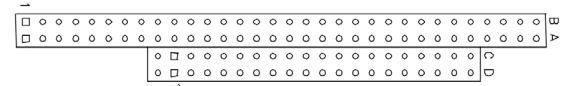
IDE1

Standard IDE 44-pin Connector

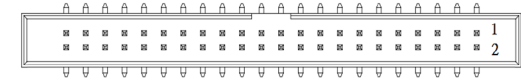

PS: Pin 41, 42: +5V/1.5A max

JP_IDE2

IDE1 Vcc Jumper Setting (Pitch: 2.54mm)

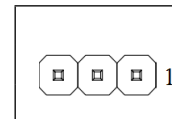

Short	Function
1-2	+5V / 1.5A (default for HDD)
2-3	+3.3V / 1.5A

CN_FPIO1

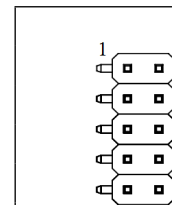
 Power/HDD LED & Reset Button Cable Connector
(Pitch: 2.54mm)

Pin #	Signal	Pin #	Signal
1	HDD LED+	2	Power LED+
3	HDD LED-	4	Power LED-
5	Reset SW+	6	NC
7	Reset SW-	8	NC
9	NC	10	NC

CN_COM2
RS-232 Port Connector (Pitch: 2.54mm)

	Pin #	Signal	Pin #	Signal
	1	DCD	2	DSR
	3	RxD	4	RTS
	5	TxD	6	CTS
	7	DTR	8	RI
	9	GND	10	NC

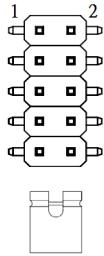
SW_COM2
CN_COM3 & CN_COM4 Jumper Setting (Pitch: 2mm)

Mode	Pin 9-10	Pin 7-8	Pin 5-6	Pin 3-4	Pin 1-2	Mode Description
000	Open	Open	Short	Short	Short	RS422 Full Duplex
001	Open	Open	Short	Short	Open	RS232 Pure
010	Open	Open	Short	Open	Short	RS485 Half Duplex (TXEN#)
100	Open	Open	Open	Short	Short	RS422 Full Duplex w/ termination
101	Open	Open	Open	Short	Open	Reserved
110	Open	Open	Open	Open	Short	RS485 Half Duplex w/ termination (TXEN#)
111	Open	Open	Open	Open	Open	Reserved

CN_KM1
KB/MS Cable Connector (Pitch: 2mm)

	Pin #	Signal
	1	MS DAT
	2	KB DAT
	3	GND
	4	+5V
	5	MS CLK
6	KB CLK	

CN_USB1
USB 2.0 Cable Connector (Pitch: 2.54mm)
CN_USB2

	Pin #	Signal	Pin #	Signal
	1	+5V	2	+5V
	3	USB Port A -	4	USB Port B -
	5	USB Port A +	6	USB Port B +
	7	GND	8	GND
	9	NC	10	NC

CN_I2C1
I2C Cable Connector (Pitch: 2.54mm)

	Pin #	Signal
	1	Vcc Setting by JP_I2C1
	2	DAT
	3	CLK
	4	NC
5	GND	

JP_I2C1
CN_I2C1 Vcc Jumper Setting (Pitch: 2.54mm)

	Short	Function
	1-2	+3.3V / 1.5A (default)
	2-3	+5V / 1.5A

CN_GP1
16bits GPIO Cable Connector (Pitch: 2mm)
CN_GP2

	Pin #	Signal	Pin #	Signal
	1	GP00 / GP10	2	GP07 / GP17
	3	GP01 / GP11	4	GP06 / GP16
	5	GP02 / GP12	6	GP05 / GP15
	7	GP03 / GP13	8	GP04 / GP14
	9	GND	10	Vcc setting by JP_GP1

Note 1: w/o protection & isolation.

Note 2: 3.3V w/ 5V I/O tolerant.

JP_GP1
CN_GP1 & CN_GP2 Vcc Jumper Setting (Pitch: 2.54mm)

	Short	Function
	1-2	+3.3V / 1.5A (default)
	2-3	+5V / 1.5A

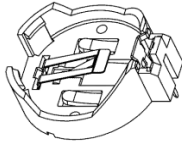
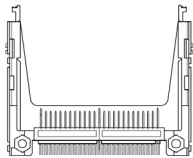
CN_BAT1
CR2032 Battery Holder

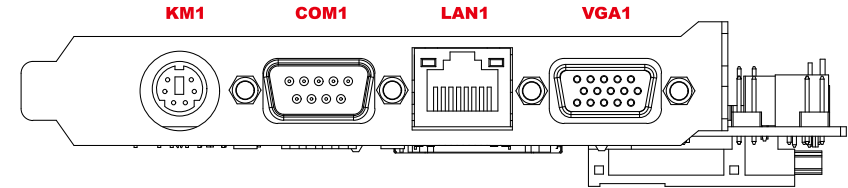
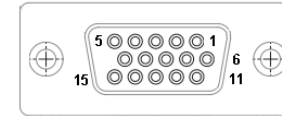
Headers/Connectors Pin Define & Jumper Setting (Bottom)
CF1
Standard CF Memory Card Connector

MSATA1
mSATA Connector

Panel I/O Connectors Definition

VGA1
Standard VGA (D-Sub15 / Female) Connector

LAN1
Standard IEEE802.3 & RJ45 Connector

	LED		10Mbps	100Mbps
	LED1	Link	Green	Green
	LED2	Active	Yellow Blinking	Yellow Blinking

COM1
Standard RS232/DTE (D-Sub9 / Male) Connector

	Pin #	Signal	Pin #	Signal
	1	DCD	2	RX
	3	TX	4	DTR
	5	GND	6	DSR
	7	RTS	8	CTS
	9	RI		

KM1
PS/2 Keyboard & Mouse Mixed Connector

	Pin #	Signal	Pin #	Signal
	1	KB_DAT	2	MS_DAT
	3	GND	5	+5V
	6	KB_CLK	8	MS_CLK

Board Dimension

(Unit: mm)

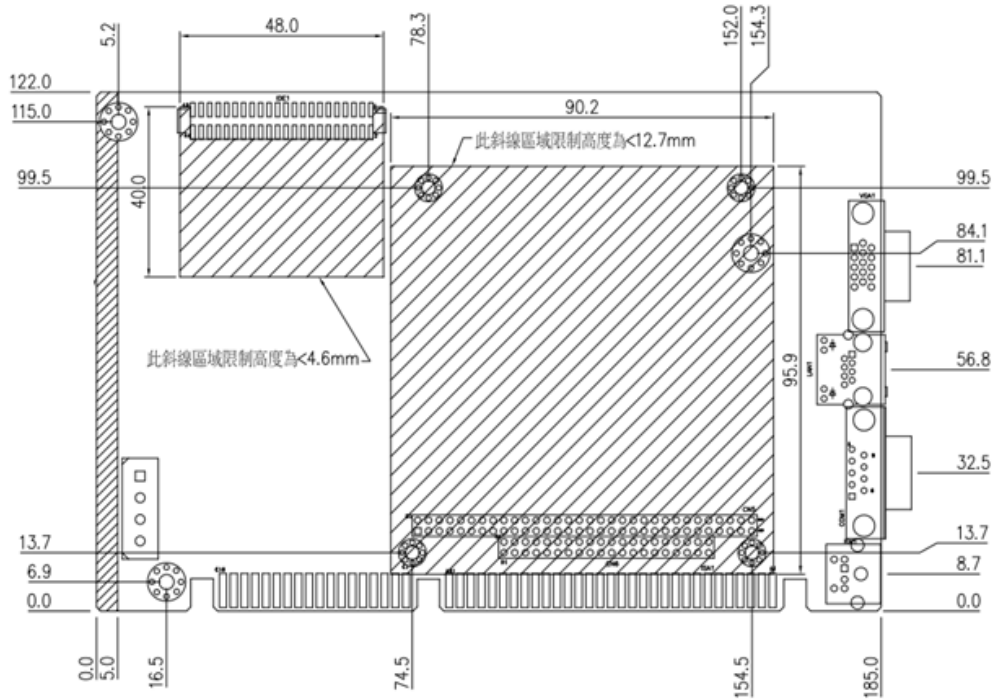

(end)